

Invoice to:	
Name:	
Street:	
Town:	Postal code:
E-Mail:	
Tel:	Fax:

Deliver to:	
Name:	
Street:	
Town:	Postal code:
E-Mail:	
Tel:	Fax:

Order date:
Purchase order:

Marked for:
-------------

Base Pricing		
<input type="checkbox"/>	Band 1	£955
<input type="checkbox"/>	Band 2	£935
<input type="checkbox"/>	Band 3	£915
<input type="checkbox"/>	Band 4	£895

Fax number: +44 (0)845 605 66 89

Email: orders@sunmed.co.uk

Crash tested &amp; Passed

Max. user weight: 125kg

**CLIENT MEASUREMENT**
**SEAT WIDTH SELECTION** - measured from outside frame tube to outside frame tube

<input type="radio"/>	Base with tilt Size 1	(seat width 30cm; seat depth adjustable from 37,5 - 45 cm)	ZRS010104
<input type="radio"/>	Base with tilt Size 2	(seat width 35cm; seat depth adjustable from 37,5 - 45 cm)	ZRS010105
<input type="radio"/>	Base with tilt Size 3	(seat width 40cm; seat depth adjustable from 37,5 - 45 cm)	ZRS010106

**SEAT DEPTH SELECTION** - only factory setting selection; all seat depths are adjustable from 37,5 - 45 cm

<input type="radio"/>	37,5 cm	SD375
<input type="radio"/>	40,0 cm	SD40
<input type="radio"/>	42,5 cm	SD425
<input type="radio"/>	45,0 cm	SD45

**SEAT HEIGHT SELECTION** - in dependance of front castor, rear wheel and center of gravity

Front Castor	Rear Wheel	Center of Gravity	Seat Height in cm																	
			43	44	45	46	47	48	49	50	51	52								
6"	16"	Forward	<input type="radio"/>	<input type="radio"/>	<input type="radio"/>	<input type="radio"/>	<input type="radio"/>	<input type="radio"/>	<input type="radio"/>	<input type="radio"/>										
	22"											<input type="radio"/>								
	24"																			
6"	16"	Set back	<input type="radio"/>	<input type="radio"/>	<input type="radio"/>	<input type="radio"/>	<input type="radio"/>													
	22"								<input type="radio"/>	<input type="radio"/>	<input type="radio"/>									
	24"																			
7"	16"	Forward					<input type="radio"/>	<input type="radio"/>												
	22"										<input type="radio"/>	<input type="radio"/>								
	24"																			
7"	16"	Set back				<input type="radio"/>	<input type="radio"/>													
	22"								<input type="radio"/>	<input type="radio"/>	<input type="radio"/>	<input type="radio"/>								
	24"													<input type="radio"/>						
8"	16"	Forward							<input type="radio"/>	<input type="radio"/>										
	22"										<input type="radio"/>	<input type="radio"/>	<input type="radio"/>	<input type="radio"/>						
	24"														<input type="radio"/>					
8"	16"	Set back									<input type="radio"/>	<input type="radio"/>	<input type="radio"/>	<input type="radio"/>	<input type="radio"/>					
	22"														<input type="radio"/>	<input type="radio"/>	<input type="radio"/>	<input type="radio"/>	<input type="radio"/>	
	24"																<input type="radio"/>	<input type="radio"/>	<input type="radio"/>	<input type="radio"/>

Center of Gravity (CoG)

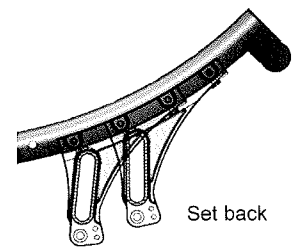

Forward

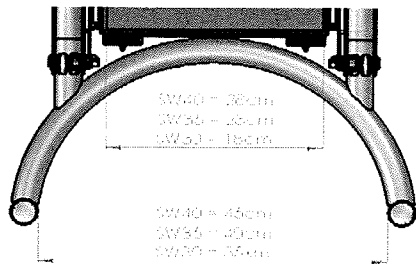

Chair dimensions

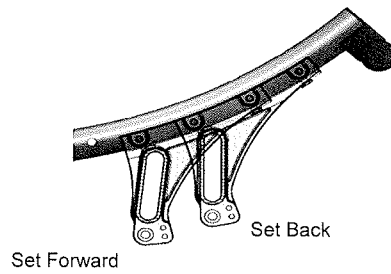

Chair characteristic

**Set Forward**

- easy to push & to tip
- short wheelbase

**Set Back**

- tip resistant
- longer wheelbase

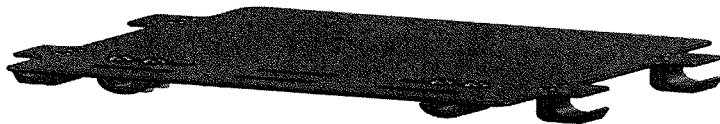

Base plate

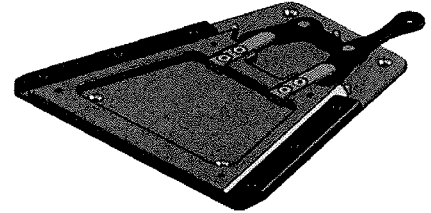

Trapezoid adapter complete



Down Town Two Grip

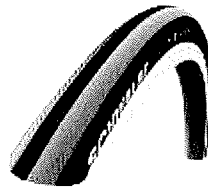

Right Run



Marathon Plus

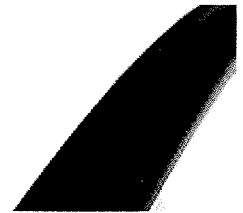

Solid



Aluminium silver anodized

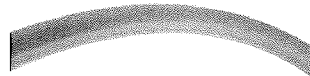

Coloured Aluminum pushrim

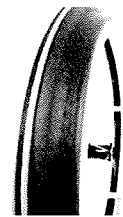

Maxgrepp

**Technical Data Overview:**

**Max. overall height:** 80 - 145 cm  
**Max. overall length:** 90 - 145 cm  
**Max. overall width:** 53 - 63 cm

**Max. turning circle:** 750 mm  
**Max. safe slope:** 10°  
**Chair weight:** from 18 kg  
**Dismantled weight:** 14 - 22 kg  
**Weight of heaviest part:** 2,1 kg

Product is **crash tested according to ISO 7176-19** and therefore approved for transportation in a vehicle  
 For transport without a user the chair must be safely clamped in the vehicle

All changes in the configuration might change the seat heights.  
 Manufacturing tolerances of +/- 1 cm

● = Standard    ○ = No cost option    □ = Cost option

£

<b>SEAT</b>		
ZRS020109	● Seat plate	
ZRS020151	□ Trapezoid adapter complete, aluminium (L: 30cm; W (front): 28cm; W (back): 14cm)	(not mounted)
ZRS090018	○ Positioning belt	
<b>JAY Cushions - for complete product range see Jay order forms:</b>		
JAY020002	□ JAY Basic	(not with Trapezoid adapter)
JAY020003	□ JAY Soft Combi P	(not with Trapezoid adapter)
JAY020001	□ JAY Easy Visco	(not with Trapezoid adapter)
<b>CASTOR TYRES</b>		
ZRS080301	○ Solid	(only 6"/7")
ZRS080302	○ Soft solid	(only 6"/8")
ZRS080305	○ Pneumatic	
<b>REAR WHEEL TYRES</b>		
ZRS070102	○ Solid	
ZRS070101	○ Right Run	(pneumatic) (only 22"/24")
ZRS070106	□ 24" Two grip "down town"	(pneumatic) (only 24")
ZRS070104	□ Marathon plus evolution	(pneumatic) (only 24")
<b>HANDRIMS</b>		
ZRS070202	○ Aluminium silver anodized	(only 22"/24")
ZRS070201	○ Aluminium clear powdercoated	(only 22"/24")
ZRS070203	□ Aluminium colour powdercoated	(only 22"/24")
ZRS070208	□ Maxgrepp	(only 22"/24")
ZRS070317	○ Handrim mounting close 17mm	(not with 16" rear wheel)
<b>WHEEL LOCKS</b>		
ZRS070008	● Drumbrake wheel	
ZRS060008	□ Kneelever wheel lock with extension tubes	(only 22" / 24")
<b>SPOKE GUARDS</b> (only 22" / 24")		
ZRS070831	○ Transparent	
ZRS070826	○ Rotation	ZRS070815 ○ Graphic    ZRS070804 ○ Bibbo
ZRS070810	○ Fantasy	ZRS070813 ○ Galactica    ZRS070805 ○ Cheese
ZRS070823	○ Princess	ZRS070808 ○ Dancing Bear    ZRS070818 ○ Jungle Fever
ZRS070816	○ Happy Lions	ZRS070832 ○ Water World    ZRS070825 ○ Randolf
ZRS070819	○ Monkeys	ZRS070821 ○ Pirates    ZRS070811 ○ Feather
ZRS070820	○ Oriental	ZRS070824 ○ Racing    ZRS070809 ○ Dirt Race
ZRS070829	○ Superhero	ZRS070814 ○ Graffiti    ZRS070806 ○ Chrome Wheel
ZRS070817	○ Hot Wheels	ZRS070802 ○ Basketball    ZRS070803 ○ Basketball 2
ZRS070822	○ Pool	ZRS070812 ○ Flying Water    ZRS070828 ○ Space
ZRS070827	○ Silk	ZRS070801 ○ Abstract    ZRS070807 ○ Creative
ZRS070830	○ Tiger	ZRS070833 ○ Zebra
<b>SIDEGUARDS</b>		
ZRS040000	○ Omit sideguard	
ZRS040109	□ Fender sideguard	(not in combination with single post sideguard; square welded receiver or 16" wheels)
ZRS040052	□ Single post tool height & depth adjustable (33 cm)	(not in combination with fender sideguard; square welded receiver)
Square welded receiver for third party armrest (15 x 15 mm; black)		
ZRS040124	□ mounted	ZRS040125 □ not mounted
<b>Push bar, angle- and height adjustable</b>		
ZRS030206	● Push bar, angle- and height adjustable	

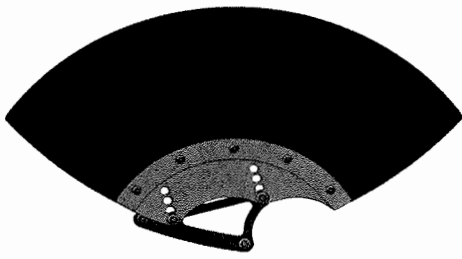

Fender sideguard

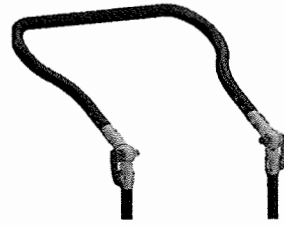

Push Bar angle adjustable

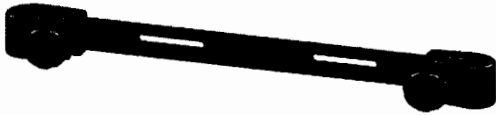

Backrest fixation, sliding

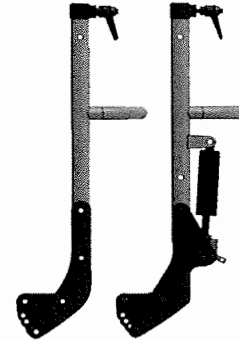

Angle adj. Back

Reclining back



Headrest

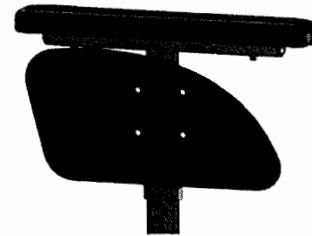

Single post tool height & depth adjustable (33cm)

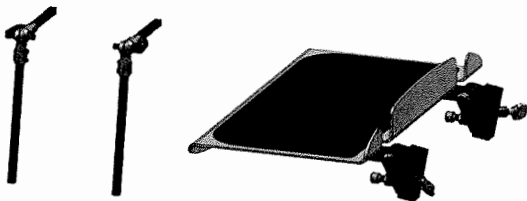

Platform footrest, adjustable foot angle, flip up with heel stop

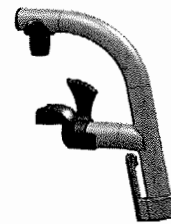

Divided footplates, aluminium (frame colour)



Square welded receiver for own footrest



Square welded receiver for own sideguard



Elevating legrest



Square welded receiver for own headrest

● = Standard    ○ = No cost option    □ = Cost option

£

<b>BACKRESTS</b>	
ZRS030012	○ Angle adjustable back (90° - 120°; SD45 only 90°-110°)
ZRS030526	○ 90°
ZRS030529	○ 105°
ZRS030527	○ 95°
ZRS030531	○ 110°
ZRS030528	○ 100°
ZRS030532	○ 115°
ZRS030533	○ 120°
ZRS030014	□ Reclining back (90° - 120°; changeable also to 85° - 115°)
ZRS030105	□ Backrest fixation, sliding (not in combination with Jay J3 back & back panel)
ZRS030305	□ Back panel
ZRS030418	□ Headrest (incl. receiver, not mounted; not in combination with Jay J3 backs)
ZRS030420	□ Square welded receiver for third party headrest (15 x 15 mm; black, not mounted)

**JAY J3 BACKS plus ACCESSORIES** - for complete product range see Jay order forms

**Jay J3 Back - Mid Contour (MC)**

Mid Thoracic (MT):	□ JAY030011	Medium - 34 cm	□ JAY030018	Tall - 38 cm
Upper Thoracic (UT):	□ JAY030013	Short - 42 cm	□ JAY030020	Medium - 46 cm (1)
Shoulder Height (SH):	□ JAY030016	Short - 53 cm (1)	□ JAY030023	Medium - 57 cm (2)
			□ JAY030026	Tall - 50 cm (1)

**Jay J3 Back - Deep Contour (DC)**

Upper Thoracic (UT):	□ JAY030014	Short - 42 cm (1)	□ JAY030021	Medium - 46 cm (1)	□ JAY030027	Tall - 50 cm (1)
Shoulder Height (SH):	□ JAY030017	Short - 53 cm (1)	□ JAY030024	Medium - 57 cm (2)		

**Jay J3 Back - Posterior Deep Contour (PDC)**

Upper Thoracic (UT):	□ JAY030031	Medium - 46 cm		
Shoulder Height (SH):	□ JAY030032	Short - 53 cm (2)		

**Jay J3 Back Headrests**

JAY030004	□ Jay flip back headrest (J3EUHDFH & J3EUHDLSP)	(only with Jay J3 backs)
JAY030006	□ Jay standard headrest (J3EUHDXH & J3EUHDLSP)	(only with Jay J3 backs)

**LEGRESTS & FOOTPLATES**

ZRS050000	○ w/o legrest			
	Aluminium hanger 80°			
ZRS050006	□ Left	ZRS050007	□ Right	(incl. 7 cm abduction)
ZRS050008	□ Pair			(7 cm abduction each side)
	Elevating legrest			
ZRS050009	□ Left	ZRS050010	□ Right	(other side aluminium hanger; incl. 7 cm abduction)
ZRS050011	□ Pair			(7 cm abduction each side)
	<b>Footplates</b>			
ZRS050020	○ Composite divided (black)			(angle adjustable)
ZRS050022	□ Aluminium divided (frame colour)			(angle- & depth adjustable)
ZRS050045	□ Platform footrest, knee angle adj. & footplate angle adj., aluminium; flip up with heel stop (frame colour; square welded tube black 15 x 15mm)			
	Square welded receiver for third party footrest			(15 x 15mm, black)
ZRS050046	□ mounted	(only in combination with seat plate)	ZRS050047	□ not mounted

**ACCESSORIES**

ZRS090000	● Tool Kit			
	□ Tip assist (step tube)			
ZRS090001	□ Left	ZRS090002	□ Right	
ZRS090003	□ Pair			(not in combination with anti-tip tubes)
	○ Anti-tip tube, flip up			
ZRS090042	○ Left	ZRS090043	○ Right	
ZRS090044	○ Pair			(not in combination with tip assist)
ZRS090070	□ Accessory box			(only in combination with anti-tip tube; max. load 13 kg)
ZRS090011	□ Tray slide on			(only in combination with single post sideguard)

(1) Only SW 35 & 40 cm

(2) Only SW 40 cm

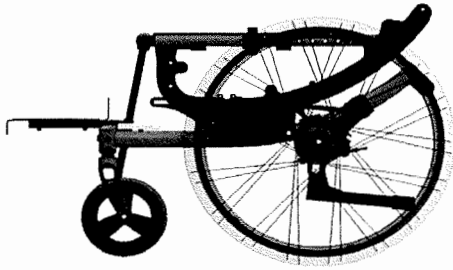

Tip assist (step tube)

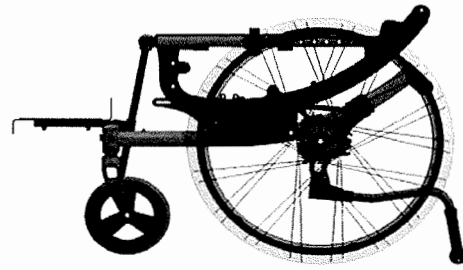

Anti tip tube, flip up

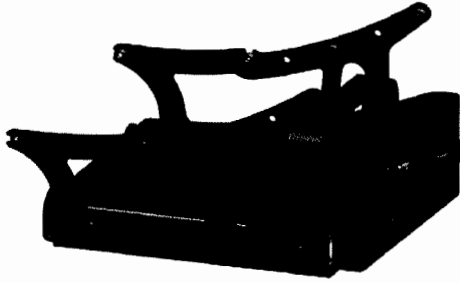

Accessory box

### Dimensions of accessory box

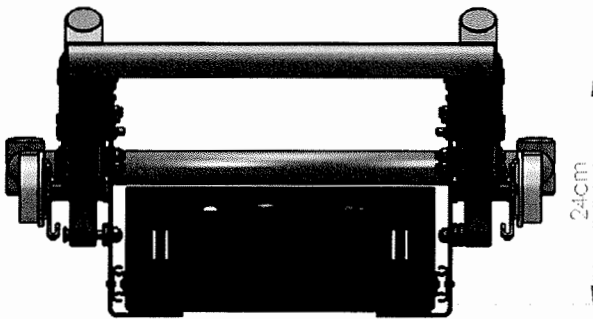

24cm

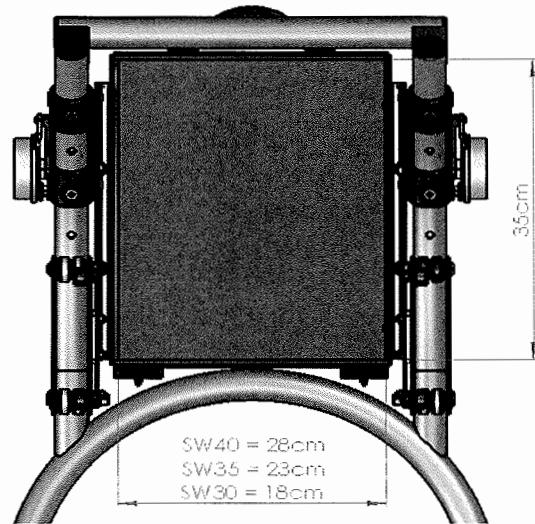

36cm

SW40 = 28cm  
SW35 = 23cm  
SW30 = 18cm

## COLOURS

Frame Colour			Handrim Colour		
ZRS100101	<input type="radio"/> 01	White RAL 9010	ZRS100201	<input type="checkbox"/> 01	White RAL 9010
ZRS100102	<input type="radio"/> 02	Brilliant Silver	ZRS100202	<input type="checkbox"/> 02	Brilliant Silver
ZRS100103	<input type="radio"/> 03	Silver matt	ZRS100203	<input type="checkbox"/> 03	Silver matt
ZRS100104	<input type="radio"/> 04	Silvermetallic	ZRS100204	<input type="checkbox"/> 04	Silvermetallic
ZRS100105	<input type="radio"/> 06	Sun Yellow	ZRS100205	<input type="checkbox"/> 06	Sun Yellow
ZRS100106	<input type="radio"/> 07	Brilliant Lime	ZRS100206	<input type="checkbox"/> 07	Brilliant Lime
ZRS100107	<input type="radio"/> 08	Matt Lime	ZRS100207	<input type="checkbox"/> 08	Matt Lime
ZRS100110	<input type="radio"/> 14	Blue	ZRS100210	<input type="checkbox"/> 14	Blue
ZRS100111	<input type="radio"/> 15	Brilliant Marine	ZRS100211	<input type="checkbox"/> 15	Brilliant Marine
ZRS100112	<input type="radio"/> 16	Matt Marine	ZRS100212	<input type="checkbox"/> 16	Matt Marine
ZRS100115	<input type="radio"/> 21	Red Ruby	ZRS100215	<input type="checkbox"/> 21	Red Ruby
ZRS100116	<input type="radio"/> 22	Brilliant Red	ZRS100216	<input type="checkbox"/> 22	Brilliant Red
ZRS100117	<input type="radio"/> 23	Matt Red	ZRS100217	<input type="checkbox"/> 23	Matt Red
ZRS100120	<input type="radio"/> 27	Graphitmetallic	ZRS100220	<input type="checkbox"/> 27	Graphitmetallic
ZRS100121	<input type="radio"/> 28	Platinmetallic	ZRS100221	<input type="checkbox"/> 28	Platinmetallic
ZRS100122	<input type="radio"/> 29	Black	ZRS100222	<input type="checkbox"/> 29	Black
ZRS100123	<input type="radio"/> 31	Matt black	ZRS100223	<input type="checkbox"/> 31	Matt black
ZRS100124	<input type="radio"/> 32	Signal white	ZRS100224	<input type="checkbox"/> 32	Signal white
ZRS100125	<input type="radio"/> 33	Pink	ZRS100225	<input type="checkbox"/> 33	Pink
ZRS100126	<input type="radio"/> 34	Dark chocolate metallic	ZRS100226	<input type="checkbox"/> 34	Dark chocolate metallic
ZRS100127	<input type="radio"/> 35	Skyblue	ZRS100227	<input type="checkbox"/> 35	Skyblue
ZRS100128	<input type="radio"/> 36	Cyan-Metallic	ZRS100228	<input type="checkbox"/> 36	Cyan-Metallic
ZRS100129	<input type="radio"/> 37	Mars red	ZRS100229	<input type="checkbox"/> 37	Mars red
ZRS100131	<input type="radio"/> 39	Capuccino	ZRS100231	<input type="checkbox"/> 39	Capuccino
ZRS100132	<input type="radio"/> 40	Kiwi	ZRS100232	<input type="checkbox"/> 40	Kiwi
ZRS100133	<input type="radio"/> 41	Flamingo-Glitter	ZRS100233	<input type="checkbox"/> 41	Flamingo-Glitter
ZRS100134	<input type="radio"/> 42	Matt-Anthrazite	ZRS100234	<input type="checkbox"/> 42	Matt-Anthrazite

### Comments for special build:



**Zippie RS - Base Price**

Option price

Exclusive VAT

VAT.

**Total Price**

