

Item Price -	Order no.:  -----
--------------	-------------------------

## discovery tmax

Article number: 470G22=00000\_K



<input type="checkbox"/> Provide estimate only		<input type="checkbox"/> Order	
Billing address/customer number			
Delivery address			
Sales person		Name	
		.....	
		Date	Signature
<p>By placing the order, you agree to comply with the instructions for use/service manuals for accessories and products of other manufacturers when combining them with an Ottobock product, in addition to the instructions for use/service manuals of the respective Ottobock products. Also you confirm to have read, understood and accepted, our general terms and conditions. In addition, you agree, upon placing an order, to conduct your own conformity assessment or approval in accordance with national requirements if and when you implement modifications or attachments that do not meet the specifications of Ottobock instructions for use/service manuals.</p>			

### Standard equipment

- Seat tilts from -5° to +50°
- Drive wheels and caster wheels PU
- Individual push handles

Max. load capacity 136 kg/300 lbs

When adapting seating systems to the discovery tmax, consider the weight of the seating system itself together with the patient weight in regards to max. loading of the discovery tmax.



Height-adjustable push bar



Transport mounting loop



Side panel

Model		
SG 30	<input type="checkbox"/>	Kids
SG 31	<input type="checkbox"/>	Adult

Seat plate		
SA 10	<input type="checkbox"/>	Without
SA 11	<input type="checkbox"/>	Standard (Alu)

Seat cushion, see separate order form 647F264 (seat plate recommended!)

Seat plate overview				
Seat depth \ Seat width	300 mm – 400 mm (12" – 16")	350 mm – 450 mm (14" – 18")	400 mm – 500 mm (16" – 20")	450 mm – 550 mm (18" – 22")
300 mm – 400 mm (12" – 16")	471C22=SS026	471C22=SS027		
375 mm – 475 mm (15" – 19")	471C22=SS028	471C22=SS029	471C22=SS036	471C22=SS037
450 mm – 550 mm (18" – 22")			471C22=SS038	471C22=SS039

Adaptation seating systems		
MC 37	<input type="checkbox"/>	<p>Kimba Neo seating unit, size 2 (see Kimba Neo order form 647F411) Not in combination with transit hooks!</p> <p><input type="checkbox"/> Adapter for Leckey Mygo size 1 and 2 (see Leckey Mygo seating system order form 647F287) Only in combination with kids model SW 425 mm/17" (non-adjustable) and SH <math>\geq</math> 425 mm/ 17" possible.</p> <p>Armrests and footrests from Tmax are not compatible. Therefore please use instead the armrests and footrests of the Leckey Mygo seating system.</p>
MC 39	<input type="checkbox"/>	<p>Adapter for Leckey Kit Seat size 1 (for seating system see order form Leckey KIT Seat 647F380) Only in combination with adults model SW 475 mm/19" (non-adjustable) and SH <math>\geq</math> 450 mm/ 18". Not in combination with transit hooks!</p> <p>Footrests from Tmax are not compatible. Therefore please use instead the footrests of Leckey KIT Seat. Armrests of Leckey KIT Seat are not compatible. Therefore please use instead the armrests and therapy tray of Tmax.</p>
MC 41	<input type="checkbox"/>	Trapezoid adaption, includes adapter fixture (only in combination with seat plate, not for use with "kid's model"; seat depth minimum 425 mm/17")

Please check off your desired pre-settings:

Model Kids*						
		Seat width (between armrests)				
		300 mm (12")	325 mm (13")	350 mm (14")	375 mm (15")	400 mm (16")
Seat depth	300 mm (12")	<input type="checkbox"/>	<input type="checkbox"/>	<input type="checkbox"/>	<input type="checkbox"/>	<input type="checkbox"/>
	325 mm (13")	<input type="checkbox"/>	<input type="checkbox"/>	<input type="checkbox"/>	<input type="checkbox"/>	<input type="checkbox"/>
	350 mm (14")	<input type="checkbox"/>	<input type="checkbox"/>	<input type="checkbox"/>	<input type="checkbox"/>	<input type="checkbox"/>
	375 mm (15")	<input type="checkbox"/>	<input type="checkbox"/>	<input type="checkbox"/>	<input type="checkbox"/>	<input type="checkbox"/>
	400 mm (16")	<input type="checkbox"/>	<input type="checkbox"/>	<input type="checkbox"/>	<input type="checkbox"/>	<input type="checkbox"/>

\* There may be variations of +/- 1 cm.

Please check off your desired pre-settings:

Model Adult*										
		Seat width (between armrests)								
		350 mm (14")	375 mm (15")	400 mm (16")	425 mm (17")	450 mm (18")	475 mm (19")	500 mm (20")	525 mm (21")	550 mm (22")
Seat depth	300 mm (12")	<input type="checkbox"/>	<input type="checkbox"/>	<input type="checkbox"/>	<input type="checkbox"/>	<input type="checkbox"/>				
	325 mm (13")	<input type="checkbox"/>	<input type="checkbox"/>	<input type="checkbox"/>	<input type="checkbox"/>	<input type="checkbox"/>				
	350 mm (14")	<input type="checkbox"/>	<input type="checkbox"/>	<input type="checkbox"/>	<input type="checkbox"/>	<input type="checkbox"/>				
	375 mm (15")	<input type="checkbox"/>	<input type="checkbox"/>	<input type="checkbox"/>	<input type="checkbox"/>	<input type="checkbox"/>	<input type="checkbox"/>	<input type="checkbox"/>		
	400 mm (16")	<input type="checkbox"/>	<input type="checkbox"/>	<input type="checkbox"/>	<input type="checkbox"/>	<input type="checkbox"/>	<input type="checkbox"/>			
	425 mm (17")	<input type="checkbox"/>	<input type="checkbox"/>	<input type="checkbox"/>	<input type="checkbox"/>	<input type="checkbox"/>	<input type="checkbox"/>			
	450 mm (18")	<input type="checkbox"/>	<input type="checkbox"/>	<input type="checkbox"/>	<input type="checkbox"/>	<input type="checkbox"/>	<input type="checkbox"/>	<input type="checkbox"/>	<input type="checkbox"/>	<input type="checkbox"/>
	475 mm (19")	<input type="checkbox"/>	<input type="checkbox"/>	<input type="checkbox"/>	<input type="checkbox"/>	<input type="checkbox"/>	<input type="checkbox"/>	<input type="checkbox"/>	<input type="checkbox"/>	<input type="checkbox"/>
	500 mm (20")			<input type="checkbox"/>	<input type="checkbox"/>	<input type="checkbox"/>	<input type="checkbox"/>	<input type="checkbox"/>	<input type="checkbox"/>	<input type="checkbox"/>
	525 mm (21")			<input type="checkbox"/>	<input type="checkbox"/>	<input type="checkbox"/>	<input type="checkbox"/>	<input type="checkbox"/>	<input type="checkbox"/>	<input type="checkbox"/>
	550 mm (22")			<input type="checkbox"/>	<input type="checkbox"/>	<input type="checkbox"/>	<input type="checkbox"/>	<input type="checkbox"/>	<input type="checkbox"/>	<input type="checkbox"/>

\* There may be variations of +/- 1 cm.

Default seat width range

<input type="checkbox"/>	30 – 40 cm/12" – 16" (only for model kids)
<input type="checkbox"/>	35 – 45 cm/14" – 18" (only for model adults)
<input type="checkbox"/>	40 – 50 cm/16" – 20" (only for model adults)
<input type="checkbox"/>	45 – 55 cm/18" – 22" (only for model adults)

Default seat depth range



<input type="checkbox"/>	30 – 40 cm/12" – 16"
<input type="checkbox"/>	37,5 – 47,5 cm/15" – 19" (only for model adults)
<input type="checkbox"/>	45 – 55 cm/18" – 22" (only for model adults)

Please selected desired seat height:				
Seat height pre-settings – Kids				
		Caster wheel size		
		6"	7"	8"
Rear wheel size	12 1/2"	<input type="checkbox"/> 350 mm (14") <input type="checkbox"/> 375 mm (15") <input type="checkbox"/> 400 mm (16") <input type="checkbox"/> 425 mm (17") <input type="checkbox"/> 450 mm (18")	<input type="checkbox"/> 350 mm (14") <input type="checkbox"/> 375 mm (15") <input type="checkbox"/> 400 mm (16") <input type="checkbox"/> 425 mm (17") <input type="checkbox"/> 450 mm (18")	<input type="checkbox"/> 400 mm (16") <input type="checkbox"/> 425 mm (17") <input type="checkbox"/> 450 mm (18") <input type="checkbox"/> 475 mm (19") <input type="checkbox"/> 500 mm (20")
	16"	<input type="checkbox"/> 325 mm (13") <input type="checkbox"/> 350 mm (14") <input type="checkbox"/> 375 mm (15") <input type="checkbox"/> 400 mm (16") <input type="checkbox"/> 425 mm (17")	<input type="checkbox"/> 400 mm (16") <input type="checkbox"/> 425 mm (17") <input type="checkbox"/> 450 mm (18") <input type="checkbox"/> 475 mm (19") <input type="checkbox"/> 500 mm (20")	<input type="checkbox"/> 400 mm (16") <input type="checkbox"/> 425 mm (17") <input type="checkbox"/> 450 mm (18") <input type="checkbox"/> 475 mm (19") <input type="checkbox"/> 500 mm (20")
	22"	<input type="checkbox"/> 325 mm (13") <input type="checkbox"/> 350 mm (14") <input type="checkbox"/> 375 mm (15") <input type="checkbox"/> 400 mm (16") <input type="checkbox"/> 425 mm (17") <input type="checkbox"/> 450 mm (18")	<input type="checkbox"/> 350 mm (14") <input type="checkbox"/> 375 mm (15") <input type="checkbox"/> 400 mm (16") <input type="checkbox"/> 425 mm (17") <input type="checkbox"/> 450 mm (18")	
	24"	<input type="checkbox"/> 325 mm (13") <input type="checkbox"/> 350 mm (14") <input type="checkbox"/> 375 mm (15") <input type="checkbox"/> 400 mm (16") <input type="checkbox"/> 425 mm (17") <input type="checkbox"/> 450 mm (18")	<input type="checkbox"/> 350 mm (14") <input type="checkbox"/> 375 mm (15") <input type="checkbox"/> 400 mm (16") <input type="checkbox"/> 425 mm (17") <input type="checkbox"/> 450 mm (18")	<input type="checkbox"/> 400 mm (16") <input type="checkbox"/> 425 mm (17") <input type="checkbox"/> 450 mm (18") <input type="checkbox"/> 475 mm (19")

Please selected desired seat height:				
Seat height pre-settings – Adult				
		Caster wheel size		
		6"	7"	8"
Rear wheel size	12 1/2"	<input type="checkbox"/> 375 mm (15") <input type="checkbox"/> 400 mm (16") <input type="checkbox"/> 425 mm (17") <input type="checkbox"/> 450 mm (18") <input type="checkbox"/> 475 mm (19") <input type="checkbox"/> 500 mm (20")	<input type="checkbox"/> 375 mm (15") <input type="checkbox"/> 400 mm (16") <input type="checkbox"/> 425 mm (17") <input type="checkbox"/> 450 mm (18") <input type="checkbox"/> 475 mm (19") <input type="checkbox"/> 500 mm (20")	<input type="checkbox"/> 425 mm (17") <input type="checkbox"/> 450 mm (18") <input type="checkbox"/> 475 mm (19") <input type="checkbox"/> 500 mm (20")
	16"	<input type="checkbox"/> 350 mm (14") <input type="checkbox"/> 375 mm (15") <input type="checkbox"/> 400 mm (16") <input type="checkbox"/> 425 mm (17") <input type="checkbox"/> 450 mm (18") <input type="checkbox"/> 475 mm (19")	<input type="checkbox"/> 425 mm (17") <input type="checkbox"/> 450 mm (18") <input type="checkbox"/> 475 mm (19") <input type="checkbox"/> 500 mm (20")	<input type="checkbox"/> 425 mm (17") <input type="checkbox"/> 450 mm (18") <input type="checkbox"/> 475 mm (19") <input type="checkbox"/> 500 mm (20")
	22"	<input type="checkbox"/> 350 mm (14") <input type="checkbox"/> 375 mm (15") <input type="checkbox"/> 400 mm (16") <input type="checkbox"/> 425 mm (17") <input type="checkbox"/> 450 mm (18") <input type="checkbox"/> 475 mm (19") <input type="checkbox"/> 500 mm (20")	<input type="checkbox"/> 375 mm (15") <input type="checkbox"/> 400 mm (16") <input type="checkbox"/> 425 mm (17") <input type="checkbox"/> 450 mm (18") <input type="checkbox"/> 475 mm (19") <input type="checkbox"/> 500 mm (20")	
	24"	<input type="checkbox"/> 350 mm (14") <input type="checkbox"/> 375 mm (15") <input type="checkbox"/> 400 mm (16") <input type="checkbox"/> 425 mm (17") <input type="checkbox"/> 450 mm (18") <input type="checkbox"/> 475 mm (19") <input type="checkbox"/> 500 mm (20")	<input type="checkbox"/> 375 mm (15") <input type="checkbox"/> 400 mm (16") <input type="checkbox"/> 425 mm (17") <input type="checkbox"/> 450 mm (18") <input type="checkbox"/> 475 mm (19") <input type="checkbox"/> 500 mm (20")	<input type="checkbox"/> 425 mm (17") <input type="checkbox"/> 450 mm (18") <input type="checkbox"/> 475 mm (19") <input type="checkbox"/> 500 mm (20")

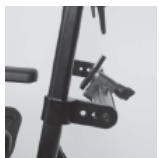
Tilting release		
ST 01	<input type="checkbox"/>	Foot release (cable free)
Caster wheels		
SF 01	<input type="checkbox"/>	6" pneumatic
SF 02	<input type="checkbox"/>	6" PU
SF 03	<input type="checkbox"/>	7" pneumatic
SF 04	<input type="checkbox"/>	7" PU
SF 05	<input type="checkbox"/>	8" pneumatic
SF 06	<input type="checkbox"/>	8" PU
Rear wheels		
SH 08	<input type="checkbox"/>	Standard
SH 07	<input type="checkbox"/>	With drum brake for attendant (not for 16")
Rear wheel size		
SG 01	<input type="checkbox"/>	12 1/2"
SG 02	<input type="checkbox"/>	16" (not in combination with drum brake)
SG 03	<input type="checkbox"/>	22"
SG 04	<input type="checkbox"/>	24"
Rear wheel tyres		
SG 10	<input type="checkbox"/>	Pneumatic
SG 11	<input type="checkbox"/>	PU
Brake		
SH 01	<input type="checkbox"/>	Wheel lock (push)
Wheel lock accessories		
SH 05	<input type="checkbox"/>	Wheel lock lever extension
Push handles/push bar		
SD 01	<input type="checkbox"/>	Push handles, rigid, incl. back tube, short (BH 53 cm/21,2") (seat plate up to centre of push handle tube) (not in combination with back systems and adapter Leckey Mygo Max)
SD 02	<input type="checkbox"/>	Push handles, rigid, incl. back tube, long (BH 63 cm/24,2") (seat plate up to centre of push handle tube) (not in combination with back systems and adapter Leckey Mygo Max)
SD 05	<input type="checkbox"/>	Push handles, rigid, incl. Back tube, height-adj. (53-63 cm/21,2"-24,2") (not in combination with back systems and adapter Leckey Mygo Max)
SD 03	<input type="checkbox"/>	Push bar, angle adj., incl. back tube, short 90° (BH 53 cm/21,2") (seat plate up to centre of push handle tube) (not in combination with adapter Leckey Mygo Max)
SD 04	<input type="checkbox"/>	Push bar, angle adj., incl. back tube, long 90° (BH 63 cm/24,2") (seat plate up to centre of push handle tube) (not in combination with adapter Leckey Mygo Max)
SD 06	<input type="checkbox"/>	Push bar, angle adj., incl. Back tube, height-adj. 75° (53-63cm/21,2"-24,2") (not in combination with adapter Leckey Mygo Max)
Back angle adjustment screwed together (please check off desired pre-settings)		
<input type="checkbox"/>	<input type="checkbox"/>	<input type="checkbox"/>
<input type="checkbox"/>	<input type="checkbox"/>	<input type="checkbox"/>
<input type="checkbox"/>	<input type="checkbox"/>	<input type="checkbox"/>
<input type="checkbox"/>	<input type="checkbox"/>	<input type="checkbox"/>
<input type="checkbox"/>	<input type="checkbox"/>	<input type="checkbox"/>
<input type="checkbox"/>	<input type="checkbox"/>	<input type="checkbox"/>
<input type="checkbox"/>	<input type="checkbox"/>	<input type="checkbox"/>
<input type="checkbox"/>	<input type="checkbox"/>	<input type="checkbox"/>



Back options		
SD 30	<input type="checkbox"/>	 <p>Cross bar with back guide for seat shell backs (only in combination with height-adjustable push handles/ push bars SD 05/ SD 06, not in combination with seat width 30 cm/12" and 32.5 cm/13")</p>





Back angle adjustment		
SD 09	<input type="checkbox"/>	 <p>With raster element, foldable (Only in combination with height-adjustable push bar SD 06)</p>
SD 10	<input type="checkbox"/>	 <p>Pin back, foldable (Not in combination with SD 09)</p>

Back systems (only in combination with push bar)		
MD 32	<input type="checkbox"/>	Backster (Only for seat width of 15"/375 mm to 20"/500 mm)
MD 40	<input type="checkbox"/>	The Back 2 (Only for seat width of 16"/400 mm to 22"/550 mm)
MD 41	<input type="checkbox"/>	The Back 3 (Only for seat width of 16"/400 mm to 22"/550 mm)
MD 42	<input type="checkbox"/>	The Back 4 (Only for seat width of 16"/400 mm to 22"/550 mm)

Backster accessories		
MD 33	<input type="checkbox"/>	Fixed support, large, left
MD 37	<input type="checkbox"/>	Fixed support, large, right
MD 34	<input type="checkbox"/>	Fixed support, small, left
MD 38	<input type="checkbox"/>	Fixed support, small, right
MD 35	<input type="checkbox"/>	Swing-away support, left
MD 39	<input type="checkbox"/>	Swing-away support, right
MD 36	<input type="checkbox"/>	Lateral/lumbar pad set

Leg support receiver		
SB 01	<input type="checkbox"/>	Without
SB 02	<input type="checkbox"/>	Standard (required for leg support SB 10, SB 11, SB 13, SB 14, SB 15, SB 25)

Leg support swing away, including angle adjustable foot plate(s)		
SB 10	<input type="checkbox"/>	 <p>Individual, 75°, composite</p>
SB 11	<input type="checkbox"/>	 <p>Individual, 75°, aluminum</p>
SB 13	<input type="checkbox"/>	 <p>Individual, 75°, depth-adjustable, aluminum</p>

SB 14	<input type="checkbox"/>		Individual, for short LLL, till 90 kg, aluminum
SB 15	<input type="checkbox"/>		Elevating, individual, calf support, aluminum
SB 25	<input type="checkbox"/>		Elevating, individual, calf support, composite
SB 12	<input type="checkbox"/>		Single-panel, flip-up, 90°
SB 03	<input type="checkbox"/>		Centre leg support 75°

#### Leg support accessories

SB 20	<input type="checkbox"/>	Calf strap (not in combination with centre leg support)
SB 21	<input type="checkbox"/>	Heel strap (not in combination with single-panel footplate)

#### Frame accessories

SA 01	<input type="checkbox"/>	Anti-tipper, right
SA 02	<input type="checkbox"/>	Anti-tipper, left
SA 03	<input type="checkbox"/>	Tip-assist, right
SA 04	<input type="checkbox"/>	Tip-assist, left

#### Arm support

SE 01	<input type="checkbox"/>	Without
SE 02	<input type="checkbox"/>	Fixed*
SE 03	<input type="checkbox"/>	Height-adjustable*

\* not in combination with Leckey Mygo Seat, please use Leckey Mygo armrests

#### Arm support padding

SE 20	<input type="checkbox"/>	Short (300 mm)
SE 21	<input type="checkbox"/>	Long (365 mm)
SE 22	<input type="checkbox"/>	Without

More arm pads, hand pad and swivel unit options see order form wheelchair accessories 647F346.

#### Arm support accessories

SZ 51	<input type="checkbox"/>	Tray (only in combination with arm support!)
Side panels		
SE 10	<input type="checkbox"/>	Without
SE 11	<input type="checkbox"/>	Standard (not in combination with Leckey Mygo/Leckey Mygo Max/Leckey KIT Seat or Kimba Neo Seat size 2)

Car transport mounting		
SK 01	<input type="checkbox"/>	Without
SK 02	<input type="checkbox"/>	Transit hooks (set with 4 pieces) (tested according to ISO 7176-19 and ANSII RESNA WC19)

Frame colour		
010	<input type="checkbox"/>	Marine Blue
021	<input type="checkbox"/>	Sparkle Granny-Smith/Metallic Green
013	<input type="checkbox"/>	Jet black RAL 9005 matte
014	<input type="checkbox"/>	Candy Red
016	<input type="checkbox"/>	Silver Metallic
023	<input type="checkbox"/>	White RAL 9016 (only in combination with Adult model)
037	<input type="checkbox"/>	Pink RAL 4010 (only in combination with Kids model)

Once printed this document is an uncontrolled version. Always check the download centre on our website ensure you have the most up to date version of this document.



Information

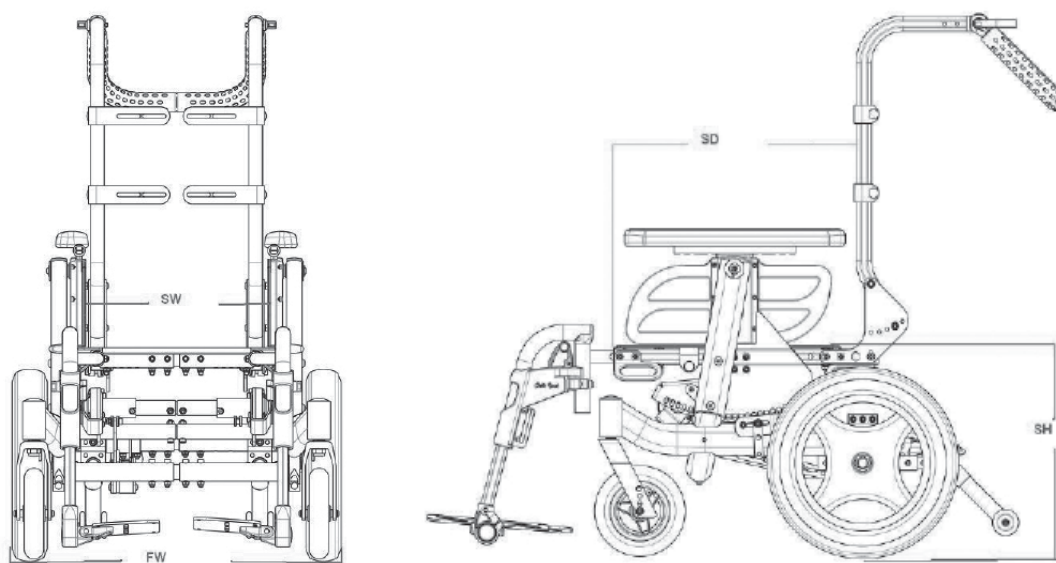

Technical data				
Overall width with 12" wheels = 10,6" (27 cm) + seat width				
Overall width with 12" wheels and drum brake = 11,4" (29 cm) + seat width				
Overall width with 16" wheels = 11" (28 cm) + seat width				
Overall width with 22" wheels = 11,8" (30 cm) + seat width				
Overall width with 22" wheels and drum brake = 12,6" (32 cm) + seat width				
Overall width with 24" wheels = 11,8" (30 cm) + seat width				
Overall width with 24" wheels and drum brake = 12,6" (32 cm) + seat width				
	Kids size 1	Adult size 2	Adult size 3	Adult size 4
Seat width (SW) (in cm)	12 – 16" (30 – 40 cm)	14 – 18" (35 – 45 cm)	16 – 20" (40 – 50 cm)	18 – 22" (45 – 55 cm)
Seat width between outside edge of seat tubing	11 – 15" (~28 – 38 cm)	13 – 17" (~33 – 43 cm)	15 – 19" (~38 – 48 cm)	17 – 21" (~43 – 53 cm)
Seat depth (SD) (in cm)	12 – 16" (30 – 40 cm)	15 – 19" (37,5 – 47,5 cm)	15 – 22" (37,5 – 55 cm)	15 – 22" (37,5 – 55 cm)
Rear wheels (in ")	12"/16"/22"/24"	12"/16"/22"/24"	12"/16"/22"/24"	12"/16"/22"/24"
Seat tubing height (SH) (in cm)	13-18" (35 – 45 cm)	16 – 20" (ca. 40 – 50 cm)	16 – 20" (ca. 40 – 50 cm)	16 – 20" (ca. 40 – 50 cm)
Seat tilt (in °)	-5° – +50°	-5° – +50°	-5° – +50°	-5° – +50°
Height of backrest from seat plate (in cm)	~21"/24" (from seat plate) ~53 cm/~61 cm (from seat plate)	~21"/24" (from seat plate) ~53 cm/~61 cm (from seat plate)	~21"/24" (from seat plate) ~53 cm/~61 cm (from seat plate)	~21"/24" (from seat plate) ~53 cm/~61 cm (from seat plate)
Backrest inclination (in °)	-5° – +30°	-5° – +30°	-5° – +30°	-5° – +30°
Overall length not including footrests, anti-tipper with 12" wheels (in cm)	from approx. 21" from ~53 cm	from approx. 24" from ~61 cm	from approx. 27" from ~68.5 cm	from approx. 27" from ~68.5 cm
Total load capacity (in kg/lb)	90 kg/200 lbs	136 kg/300 lbs	136 kg/300 lbs	136 kg/300 lbs
Frame weight (not including wheels, footrests, armrests and seating unit)	15 kg/33 lbs	16 kg/35 lbs	16.5 kg/36 lbs	17 kg/37.5 lbs
Front casters (in ")	6"/7"/8"	6"/7"/8"	6"/7"/8"	6"/7"/8"